

4.2026

Cod: DARKSKY-AT01-01A-V
SOLAR LIGHTING SYSTEM



**Proposition professionnelle
pour des solutions concrètes:**

**L'alternative professionnelle
pour un éclairage continu
dans les zones résidentielles,
et la protection de l'environnement.**

Sta®LED Darksky A&O1

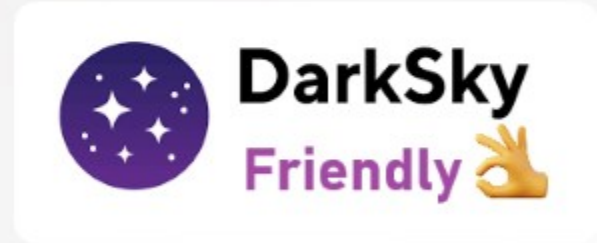

Solar Light City Latest technology
2026

Turnkey solutions available

It's in our hands to improve everything possible!



DARSKY AT01- Solar Post Top Light

The **DARSKY AT01** solar city light efficiently brightens recreational spaces, gardens, and pathways with 360-degree glare-free lighting, powered by solar energy and designed for off-grid use. Its elegant, aesthetic design enhances both home and hospitality environments, offering a stylish yet functional solution with zero operational costs. Featuring built-in lighting programs, the light's power and working time can be easily adjusted via remote control to suit

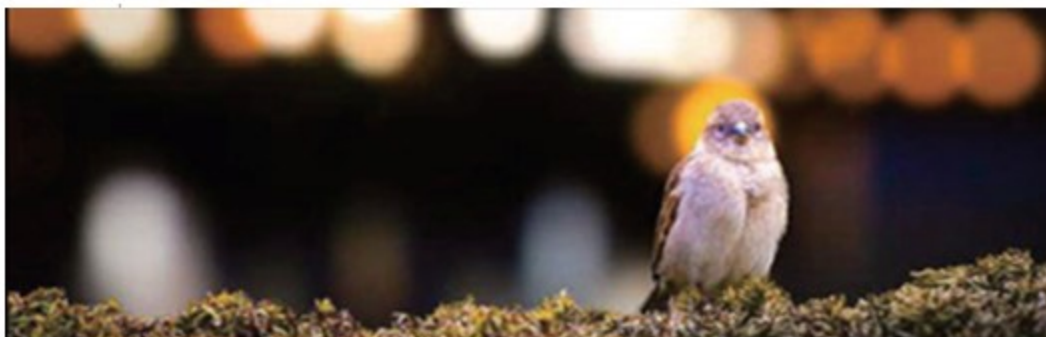

Applications

- Street, Road
- Bike Track, Pathway
- Residential, Villa
- Public Area, Park, Car Parking Lot
- Jetties, Coastal, Marina, Dock



Sta®LED Darksky A&O1

Solar Panel

42WP – 22,5 %

Battery inside

154WH - 12.8V

SOLAR CITY LIGHT

LED Light head

PLP: 18W - 2.800lm

Beam Angle

120 Degree



Color Palette for aluminium Poles

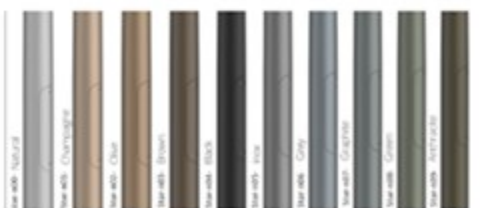

Aluminium Pole

4 meters x 4 mm

In ONE piece



ALL INCLUSIVE - 100% OFF GRID

RE-locatable
RE-usable



Quick + clean to install

Sta®LED Darksky A101

Solar Panel
42WP – 22,5 %

Battery inside
154WH - 12.8V



Aluminium Pole
4 meters x 4 mm
In ONE piece



SOLAR CITY LIGHT

LED Light head

PLP: 18W - 2.800lm

Beam Angle

120 Degree



DarkSky
Friendly 🙌





Main Specification

Model	DARKSKY AT01 (R)
Lighting Performance	18W I 2,800lm
Solar panel	42W 18V MONO
LiFePO4 battery	12.8V 154WH
CCT	2200+2700 / 3000K +4000K / 3000K+6000K
Motion sensor	Microwave
Solar Controller	High Efficiency 97% MPPT
Dimension	φ600*H455mm
Warranty	5 years





Ecological and sustainable
lighting for people,
animals & plants,
with no monthly costs.

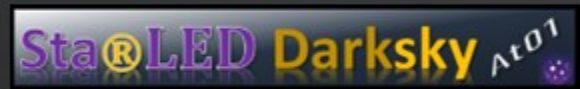

Our backyards and gardens are places of relaxation and close to our hearts, and with the same passion, we present DARKSKY AT01 as the most advanced solar CITY light for your nature-friendly living. AT01 solar city light efficiently illuminates your recreational living areas, gardens, and pathways with 360-degree beam, glare-free lighting in solar energy, and stand-alone off-grid functioning. DARKSKY AT01 is aesthetically designed for comfortable living but elegant styling suitable for home and hospitality applications with zero operational costs.

With the built-in lighting programs, the lighting power and working time could be easily adjusted as required via the remote control. The light can also work in motion detecting mode which will help to save more energy. DARKSKY AT01 is a suitable solar pedestrian light to work perfectly no matter in gulf countries with 5.5 hours of valid sunshine or in north Europe with 2.5 hours of valid sunshine.

DARKSKY AT01 solar garden light is highly customizable via the remote control in terms of color temperatures, lighting power, and working time to match the city atmosphere. Ours decade of experience in solar lighting technologies makes AT01 the perfect choice for home users and project customers, contributing to green energy and reducing carbon footprints.



COMPONENTS



A cutting-edge all-in-one, turnkey technological system.

FEATURE



Wild animals friendly with 2200K warm colors



6000 cycles class A LiFePO4 battery unit



4H / 6H / 12H optional changeable by remote



2.4G remote signals is more stable performance



Green energy from the sun never pay electricity bill



Sensitive PIR motion sensor can be ON/OFF



Dual CCT is changeable between two colors



Dusk to Dawn automatically ON/OFF

Sta®LED Darksky AT01

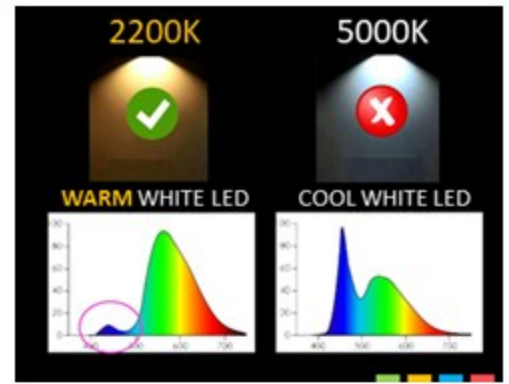

LIGHT DISTRIBUTION

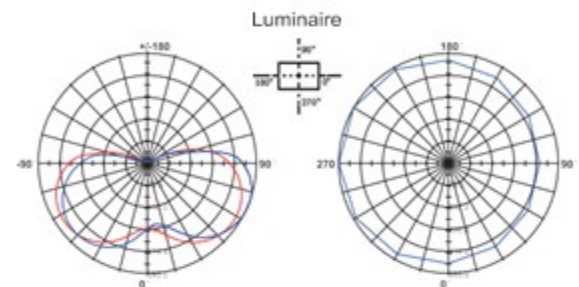

DIMENSION

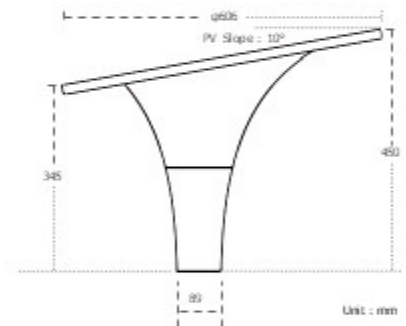

MAIN PARAMETERS

Model Name	DARKSKY AT01	Control Method	Automatic ON/OFF dusk to dawn
LED Power	18W	Solar Charge Controller	High Efficiency 97% MPPT
Luminous Flux	2,800lm max	Remote Type	2.4G radio
LED Chips	SMD2835 164pcs	Operation Distance	up to 30 meters
CRI	Ra ≥80	Sensor Type	Microwave sensor
CCT (Dual color)	2200+2700/3000K+4000K/3000K+6000K	Working Temp.	-15°C~+70°C
LED Lifetime	>100,000 hours	Pole Diameter to Fit	76mm
Solar Panel	42W 18V MONO	Package Size	62*62*26mm
Solar Panel Efficiency	>22.5%	IP & IK Rate	IP65 IK10
LiFePO4 Battery	12.8V 154WH	Certificates	CB CE ROHS IP65 LM79 LM80, MSDS
Battery Lifetime	6000 cycles @D.O.D 50%	Fixture Material	Aluminium die casting + Tempered glass
Charge & Discharge time	4 hours & >24 hours	Fixture Color	RAL9011/RAL 7016
Autonomy	2-3 days in motion detection mode	Warranty	5 Years

Hybrid System with 220V Grid Supply (Optional)

The solar street light with AC85-240V AC as backup power is designed to make solar lighting smarter and more reliable under challenging conditions, especially in areas with insufficient solar radiation during certain months or during sudden periods of prolonged bad weather.

The control system will automatically switch to AC power when the battery voltage drops significantly and the battery is depleted. It will switch back to battery power once the battery voltage recovers to full capacity. This hybrid system solution ensures uninterrupted and reliable lighting service throughout the year, eliminating any concerns about power outages.

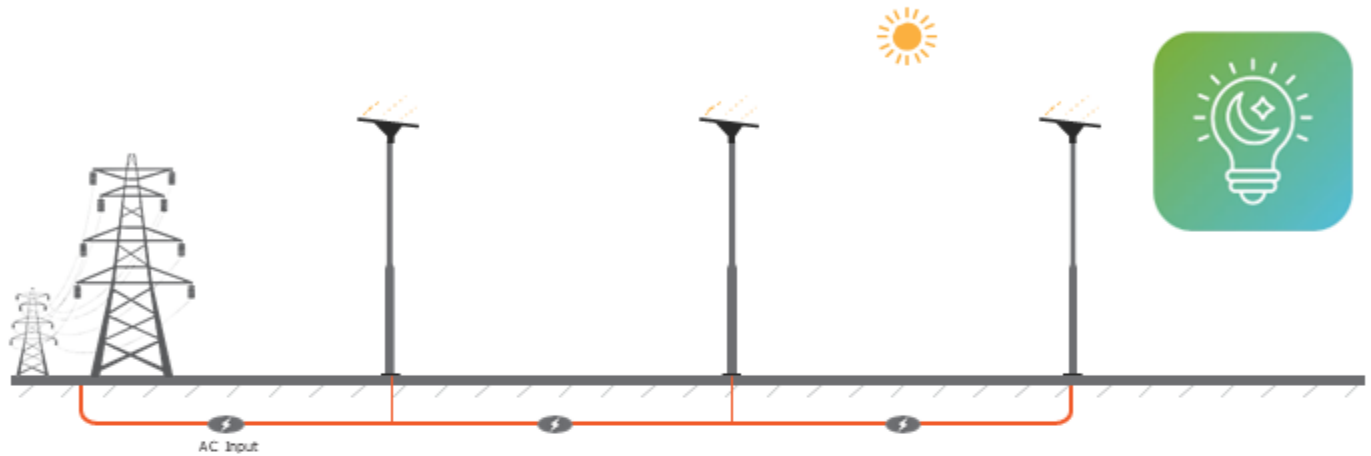

FEATURES



High reliability

Dual power supply guarantee, no risk of lighting interruption.



Energy saving

Give priority to the use of clean energy to reduce carbon emissions.



More economical

Reduce power consumption and low long-term use cost.

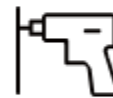

Flexible installation

Suitable for areas where solar energy resources are unstable or require high brightness.



WIRING DIAGRAM

WIRING STEPS

- 1 LED light
- 2 Battery
- 3 Solar Panel
- 4 Grid DC input

NOTE :

Connect the controller's DC terminal to the output terminal of the 12 V/ 24 V switching power supply and do not directly connect 220 VAC to the controller!

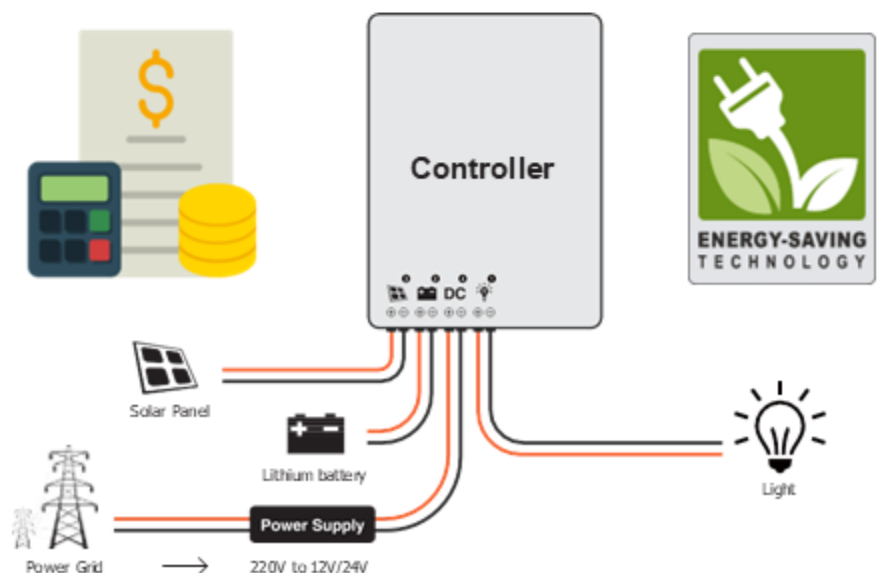

What can remote do?

Change work mode

The default setting is continuous lighting with fixed brightness, also motion sensor function is available, The luminaire works with 30% power normally and works with 100% power when the motion sensor is triggered at people come by. Saving more power with longer battery backup.

Change Time

Different lighting time durations are available as 4 hours, 6 hours, and 12 hours optional to meet different requirements. This helps to save more energy and extend the lifetime of light as well as more days backup.

Change Light Color

The color is switchable between cool white 6000K (or daylight 4000k) and warm white 2200K. Easy to set by remote as required. Winter with warm white and Summer time with cool white. Creating a comfortable atmosphere freely.

Change Light Power

The power is changeable as 20%, 40%, 60%, 80%, and 100% to adjustable according to the local solar radiation to save energy, guaranteeing the lighting service is always there even in very challenging conditions.



REMOTE CONTROL FOR
GENERAL FUNCTIONS





**DARK SKY
FRIENDLY**
for a better
FUTURE





Sta®LED Darksky At01



Private
OFF GRID
 LIGHTING



Public
OFF GRID
 LIGHTING

Solar LED streetlights
 for pedestrian areas



Aluminium Pole
 5 meter x 3 mm
 In ONE piece



Color Palette for aluminium Poles

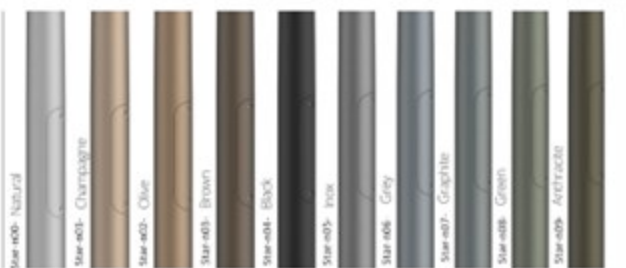

Sta®LED Darksky AED1

Serie PRO





Cod: DARKSKY-AT01-01A-
SOLAR LIGHTING SYSTEM



*L'intérêt général
est au cœur
de toutes nos actions.*

Installation, mise en service et garantie assurées par :

